



doucette
industries, inc



Call dii

Item # HSE125MP, Shell & Tube Fresh Water Condenser

For Shell & Tube applications, please consult factory.

Specifications

HP	141.3
Diameter-in.	12-3/4
Length-in.	96
Gas-IDS	3-5/8
Liquid-IDS	2-1/8
Water-FPT	5
R-410A Pump Down	275
Weight-lb.	853
Perf	1 HP = 15,000 Btuh, R-410A 85F EWT, 95F LWT, 105F CT
Design	U.L. or ASME 600 psig DWP shell 150 psig DWP tube
Construction	All carbon steel with enhanced surface copper tubes Epoxy coated tube sheets and water covers Pump down capacity at 90% full with R-410A



20 Leigh Drive,
York, Pennsylvania 17406-8474



Website: www.doucetteindustries.com



Phone: 717-845-8746
Toll-free: 800-445-7511
Fax: 717-845-2864



Commercial/Industrial: AdamM@doucetteindustries.com
Residential/Light Commercial: AdamM@doucetteindustries.com



Dimensions in inches.

Doucette Industries reserves the right to change design or specifications without notice.

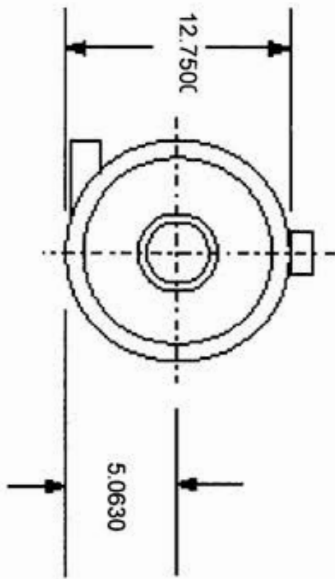
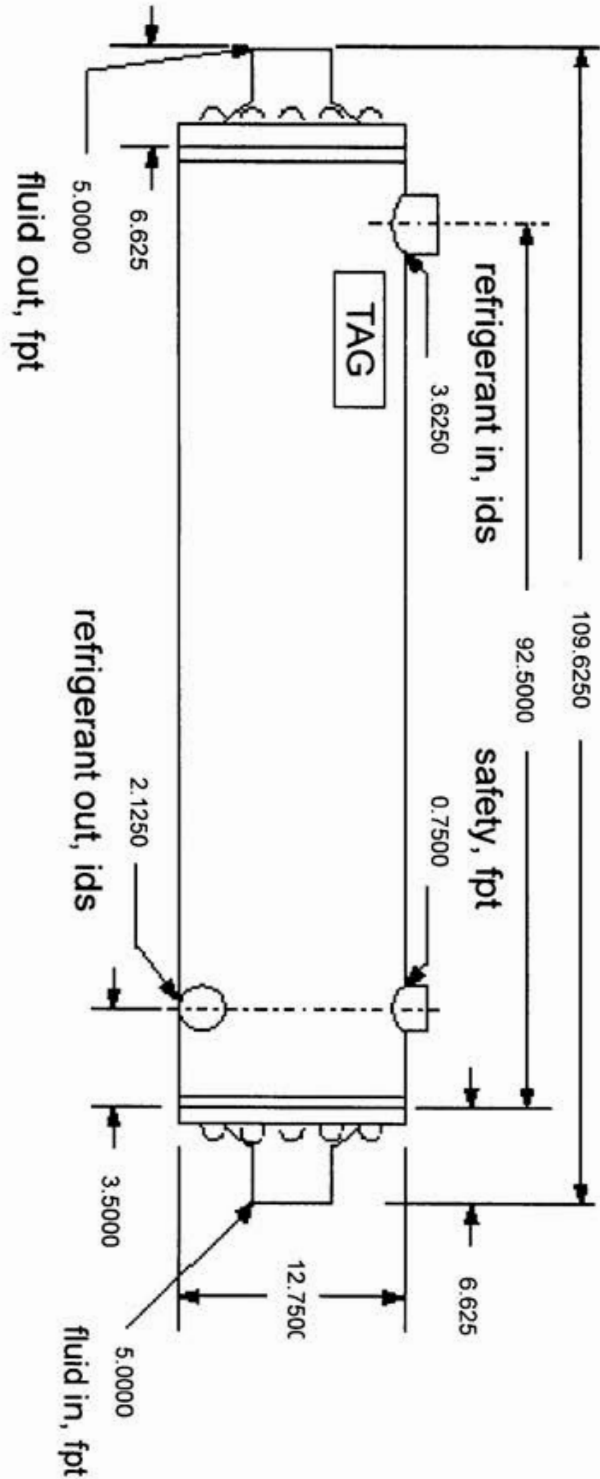

HSE-125



20 Leigh Drive,
York, Pennsylvania 17406-8474



Phone: 717-845-8746
Toll-free: 800-445-7511
Fax: 717-845-2864



Website: www.doucetteindustries.com



Commercial/Industrial: AdamM@doucetteindustries.com
Residential/Light Commercial: AdamM@doucetteindustries.com