



doucette
industries, inc



Call dii

Item # MSE1500Z, Shell & Tube Marine Condenser

For Shell & Tube applications, please consult factory.

Specifications

HP	14.9
Diameter-in.	8-5/8
Length-in.	40
Gas-IDS	1-5/8
Liquid-IDS	1-1/8
Water-FPT	1-1/4
R-22 Pump Down	47
Weight-lb.	181
Perf	1 HP = 15,000 Btuh, R-22 85F EWT, 95F LWT, 105F CT
Design	U.L. or ASME 400 psig DWP shell 150 psig DWP tube
Construction	All carbon steel shell and baffles Enhanced surface 90/10 Cupronickel tubes Epoxy coated 90/10 Cupronickel tube sheets Naval brass water covers Pump down capacity at 90% full with R-22



20 Leigh Drive,
York, Pennsylvania 17406-8474



Website: www.doucetteindustries.com



Phone: 717-845-8746
Toll-free: 800-445-7511
Fax: 717-845-2864



Commercial/Industrial: AdamM@doucetteindustries.com
Residential/Light Commercial: AdamM@doucetteindustries.com

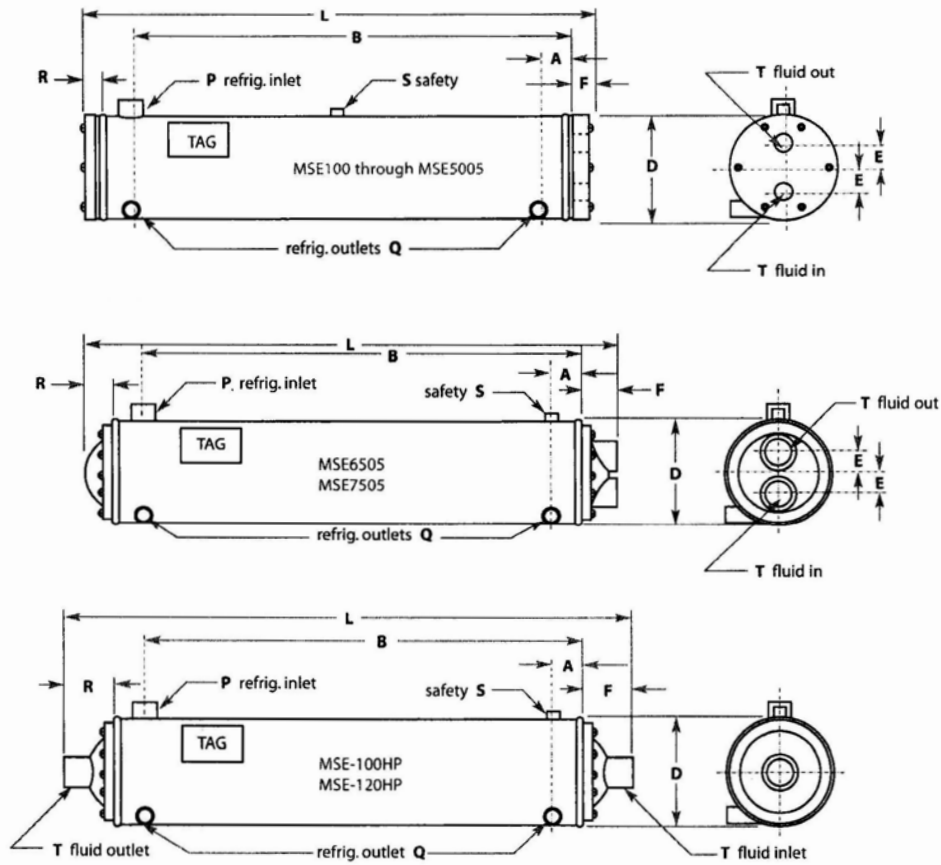

MODELS	Nominal hp		Dimensions (inches)							Connections (inches)			
	clean	fouled	D	L	A	B	E	F	R	P (ids)	Q (ids)	S (fpt)	T (fpt)
MSE-100	1.3	1.0	6	21 5/8	1 5/8	16 3/8	1 7/8	2	1 3/8	5/8	1/2	3/8	1/2
MSE-200	2.6	2.0	6	21 5/8	1 5/8	16 3/8	1 7/8	2	1 5/8	7/8	5/8	3/8	1/2
MSE-300	4.6	3.3	6 5/8	21 3/4	2	16	1	2	1 3/4	7/8	5/8	3/8	3/4
MSE-500	6.0	4.6	6 5/8	21 3/4	2 1/8	16	1	2	1 3/4	1 1/8	5/8	3/8	3/4
MSE-750	9.5	6.7	6 5/8	34 1/4	2	28	2	2 1/4	2	1 3/8	7/8	3/8	1 1/4
MSE-1005	11.7	9.5	6 5/8	40 1/4	2	33	2	2 1/4	2	1 3/8	7/8	3/8	1 1/4
MSE-1500	19.9	15.8	8 5/8	40 1/4	2 1/2	33 1/2	2 1/8	2	2 1/4	1 5/8	1 1/8	1/2	2
MSE-2005	26.7	20.2	8 5/8	64 1/2	3	57	2 1/8	2 1/4	2 1/4	2 1/8	1 1/8	1/2	2
MSE-2505	33.1	25.9	8 5/8	64 1/2	3	57	2 1/8	2 1/4	2 1/4	2 1/8	1 3/8	1/2	2
MSE-3006	39.7	31.6	8 5/8	76 1/2	3	69	2	2 1/4	2 1/4	2 5/8	1 3/8	1/2	2 1/2
MSE-3305	44.4	32.6	10 3/4	65	3	56 1/2	2 1/8	2 3/4	2 1/4	2 5/8	1 3/8	1/2	2 1/2
MSE-4005	45.8	33.6	10 3/4	65	3	56 1/2	2 1/8	2 3/4	2 1/4	2 5/8	1 5/8	1/2	2 1/2
MSE-4505	57.7	44.2	10 3/4	77	3	68 1/2	2 1/8	2 3/4	2 1/4	2 5/8	1 5/8	1/2	2 1/2
MSE-5005	59.6	45.7	10 3/4	77	3	68 1/2	2 1/8	2 3/4	2 1/4	2 5/8	1 5/8	1/2	2 1/2
MSE-6505	71.0	58.2	12 3/4	78 3/4	3 1/2	68 1/2	2 3/4	4 1/4	2 3/8	3 1/8	2 1/8	1/2	4
MSE-7505	84.8	66.1	12 3/4	78 3/4	3 1/2	68 1/2	2 3/4	4 1/4	2 3/8	3 1/8	2 1/8	1/2	4
MSE-100HP	132.2	99.8	12 3/4	133 1/2	3 1/2	116 1/2	—	6 5/8	6 5/8	3 1/8	2 1/8	1/2	5 mpt
MSE-120HP	137.2	103.6	12 3/4	133 1/2	3 1/2	115 3/4	—	6 5/8	6 5/8	3 1/8	2 1/8	1/2	5 mpt

† Tubing has high performance extended surface

Zinc plates are available for all MSE models. Indicate by adding "Z" after model number (MSE-750Z)

Clean ratings: As tested per ARI standard 450-99.

Fouled ratings: Include fouling factor coefficient of 0.00025 as calculated per ARI standard 450-99.



20 Leigh Drive,
York, Pennsylvania 17406-8474



Website: www.doucetteindustries.com



Phone: 717-845-8746
Toll-free: 800-445-7511
Fax: 717-845-2864



Commercial/Industrial: AdamM@doucetteindustries.com
Residential/Light Commercial: AdamM@doucetteindustries.com

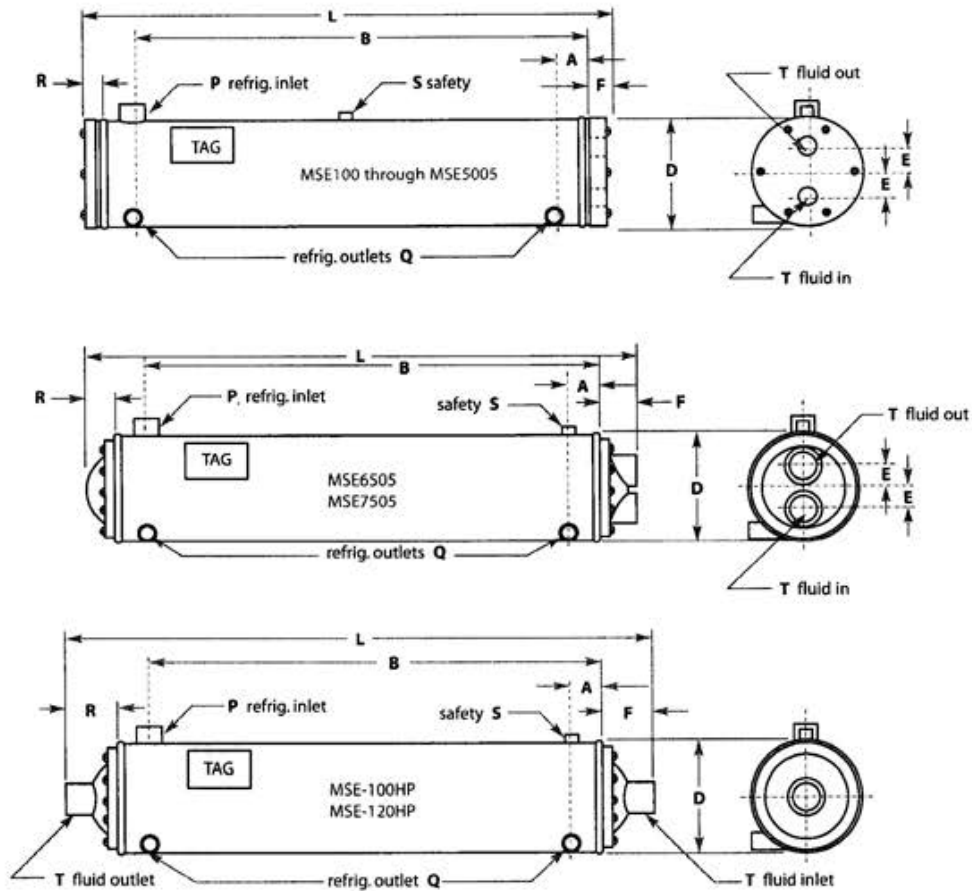

MODELS	Pumpdown Capacity (lbs)	Waterflow (gpm)		Water Pressure Drop (psi)	Shipping Weight (lbs)	Working Pressure (psi)	
		Min.	Max.			Shell Side	Tube Side
MSE-100	14	0.74	7.38	3.0	35	400	150
MSE-200	12	1.48	14.77	3.0	49	400	150
MSE-300	14	1.66	16.61	6.9	58	400	150
MSE-500	15	2.22	22.15	7.6	77	400	150
MSE-750	24	4.43	44.30	2.3	107	400	150
MSE-1005	29	4.43	44.30	5.4	121	400	150
MSE-1500	49	7.38	73.84	5.4	181	400	150
MSE-2005	86	13.29	123.90	2.5	254	400	150
MSE-2505	79	16.24	162.44	2.9	265	400	150
MSE-3006	99	14.77	147.67	5.7	286	400	150
MSE-3305	133	20.67	206.74	2.8	338	400	150
MSE-4005	129	22.15	221.51	2.5	343	400	150
MSE-4505	160	20.67	206.74	5.7	388	400	150
MSE-5005	155	22.15	221.51	5.0	394	400	150
MSE-6505	225	28.80	287.96	3.1	517	400	125
MSE-7505	215	32.49	324.88	3.2	533	400	125
MSE-100HP	358	64.98	500.00	1.3	1133	400	125
MSE-120HP	344	70.88	708.82	1.1	1158	400	125

† Tubing has high performance extended surface

Zinc plates are available for all MSE models. Indicate by adding "Z" after model number (MSE-750Z)



20 Leigh Drive,
York, Pennsylvania 17406-8474



Website: www.doucetteindustries.com



Phone: 717-845-8746
Toll-free: 800-445-7511
Fax: 717-845-2864



Commercial/Industrial: AdamM@doucetteindustries.com
Residential/Light Commercial: AdamM@doucetteindustries.com